



- Single phase
- Switching capacity 2.2 kW
- Max. cut-out pressure 12 bar
- 2-pole (N.C.)
- Acc. to EN 60947
- Flange = Die-cast aluminium



Technical Data MDR 2 acc. to 60947	
Rated insulation voltage U_i	500 V
Motor switching capacity (AC 3) $U_e=240$ V (1~)	2,2 kW
Electrical life (AC 3) Cycles	$> 1 \times 10^5$
Mechanical life Cycles	$> 5 \times 10^5$
Max. electrical cycles Cycles/h	120
Max. mechanical cycles Cycles/h	600
Rated operational current I_n at 240 V AC 3	16 A
Bursting strength P_z	> 35 bar
Permissible medium temperature Air	- 5...+ 80 °C

Technical Data MDR 2 acc. to 60947	
Permissible medium temperature Water	+ 80 °C
Degree of Protection acc. to EN 60529	IP 44
Conductor cross-section 1 .. fine stranded cable 1 x / 2 x	2,5 / 2,5 mm ²
Conductor cross-section 1 rigid cable 1 x / 2 x	2,5 / 2,5 mm ²

Diaphragm media resistance MDR 2	
Please see overview for further information.	

Pressure Switches

Condor Code	ON/OFF switch	Pressure Range In kPa	Connection	Weight (gms)	Part Number (RBS)
MDR2/600 SL G1/4 2PG11Z	-	150-700	1/4" BSP F	400	3010550
MDR2/1100 SL G1/4 EA EV2i 2PG11Z	EA	400-1200	1/4" BSP F	400	3011300
MDR2/1100 SL EV2Wi 2PG11Z	-	400-1200	1/4" BSP F	400	3011310
MDR2/1100 SL EA AEV2WS 2PG11Z	EA	400-1200	1/4" BSP F	390	3011315
MDR2/1100 SL F4-G1/4 EA AEV2WS 2PG11Z	EA	400-1200	F4 x 1/4" BSP F	380	3013265
MDR2/1100 SL F4-G1/4 EA EV2i 2PG11Z	EA	400-1200	F4 x 1/4" BSP F	380	3013268

Dimensions / Circuit Diagrams MDR 2

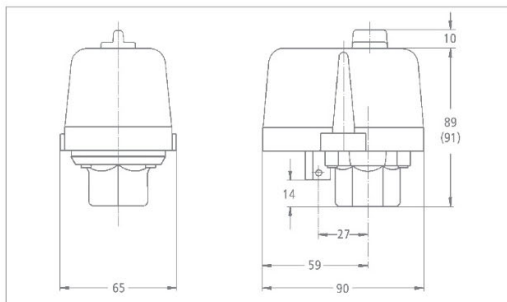

Pressure switch MDR-2

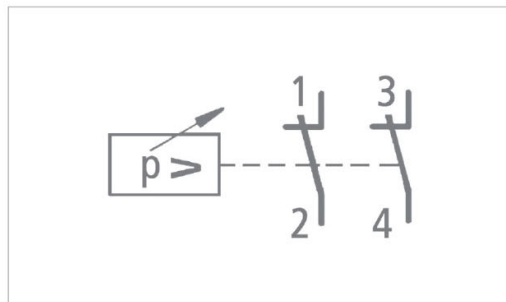

The data provided above is for information purposes only and no warranty of accuracy or reliability is given.
 Ross Brown Sales Pty Limited reserves the right to change or modify this data without prior notice.

Dimensions, Accessories MDR 2

EV 2

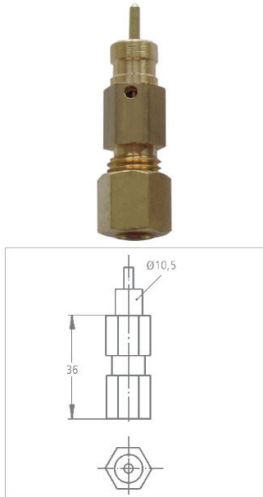

AEV 2

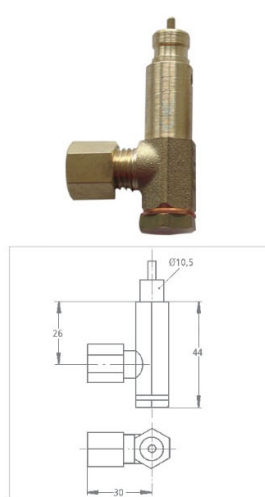

EV 2W / EV 2Wi
AEV 2W / AEV 2Wi

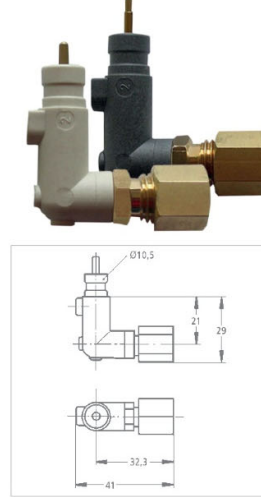

EV 2WS /
AEV 2WS

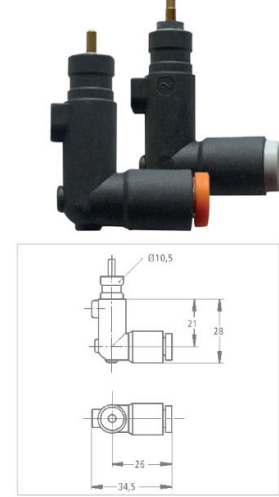

Pressure Switch Accessories

Condor Code	Description	Weight (gms)	Part Number
	Unloader valves		
EV2	With screw fitting for 6 mm plastic or copper discharge line	25	3909001
EV2i	With screw fitting for 1/4" plastic or copper discharge line	37	3909000
EV2Wi	Right-angle valve with screw fitting for 1/4" plastic or copper discharge line	15	3909009
EV2WS	Right-angle valve with quick-connect for 6 mm plastic discharge line	15	3909011
	Unloader valves for difficult motor starting conditions		
AEV2i	With screw fitting for 1/4" plastic or copper discharge line	25	3908500
AEV2W	Right-angle valve with screw fitting for 6 mm plastic or copper discharge line	15	3909012
AEV2WS	Right-angle valve with quick-connect for 6 mm plastic discharge line	15	3909010
	Cable Glands		
PG11Z	With strain Relief	12	3919200
	Cover		
H2	Cover without rotary knob	40	3913500
H2-EA	Cover with rotary knob for manual On/Off switching	40	3913600

Pressure Diagrams

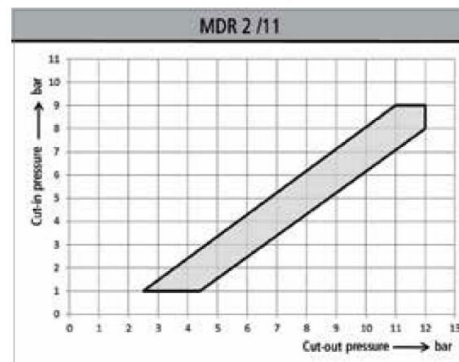
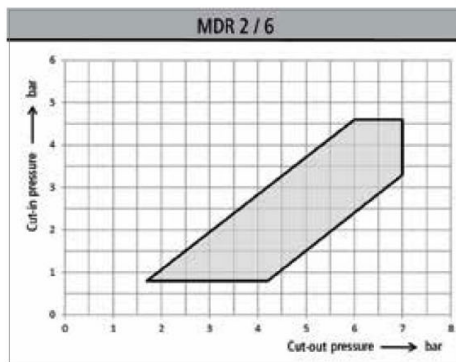

The data provided above is for information purposes only and no warranty of accuracy or reliability is given.
Ross Brown Sales Pty Limited reserves the right to change or modify this data without prior notice.